

TCL

2.0 Channel Sound Bar with Dolby Audio

6100 Series

User Manual



Contents

1	Before you begin.....	3
<hr/>		
2	Welcome.....	4
	What's in the box.....	4
	Overview of the Sound Bar.....	6
	Overview of the remote control.....	8
	Set up your Sound Bar system.....	10
	Mount your Sound Bar on the wall.....	10
	Install/replace the remote control batteries.....	14
<hr/>		
3	Connect your Sound Bar system.....	15
	Connect with an HDMI cable.....	15
	Connect with an optical cable.....	18
	Connect with a 3.5mm-to-3.5mm audio cable.....	20
	Connect your Sound Bar to power supply.....	21
	Connect the Sound Bar with your Bluetooth device.....	22
<hr/>		
4	Use your Sound Bar system.....	24
	Use your Sound Bar with the top panel or remote control.....	24
	Sound settings.....	26

Listen to music from your Bluetooth device.....	27
Use the USB cable or device.....	28
<hr/>	
5 Specifications.....	30
<hr/>	
6 Notice.....	31
Declaration of conformity.....	31
Disposal of your old product and battery.....	31
Trademarks.....	33
<hr/>	
7 FAQ.....	34

1 Before you begin

- Carefully read and observe all safety instructions in the safety leaflet
- This soundbar is intended for indoor use only. In case it accidentally gets in contact with small amounts of water, unplug immediately and use a dry cloth to remove the water.
- Unplug the soundbar if it is not used for long periods of time or during lightning storms.
- Make sure the soundbar is installed on a solid surface or solidly wall-mounted below your TV for the best experience.
- Only use AAA 1.5V non-rechargeable batteries for the remote control.
- In case any of the cables are visibly damaged or pinched, unplug the soundbar and replace the cable.
- Be careful not to sharply bend HDMI and optical cables as they may affect the performance.
- Protect your hearing by adjusting to a proper volume.

2 Welcome

Congratulations on the purchase of your new TCL Sound Bar! After it is set up and connected, you can experience a superb sound quality and state-of-the-art design to best fit your home entertainment system. You are recommended to read through this user manual which helps you set up, connect and operate the product easily and properly.

Let's get started.

What's in the box



Sound Bar



Remote control



AAA battery x 2



AC power cord



Wall anchor x 2



Wall mounting screw x 2

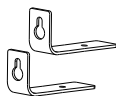

Wall mount bracket x 2

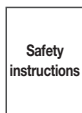

Safety leaflet





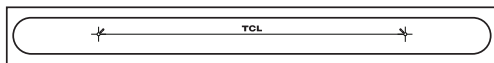

Quick Start Guide

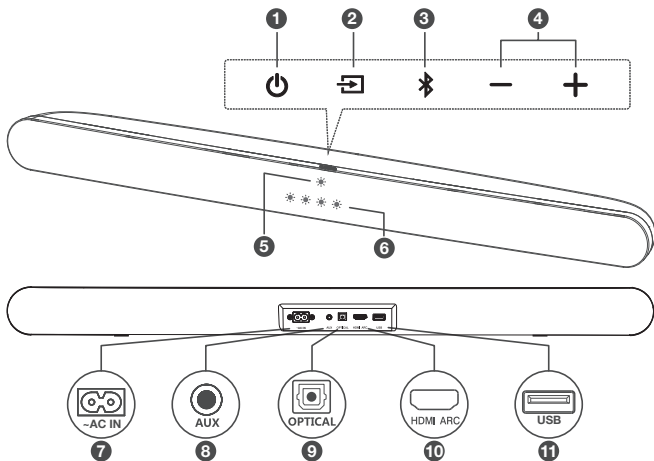

Wall mount template

Overview of the Sound Bar





-  Press to turn the Sound Bar on or to standby mode.
-  Press to switch the audio source among HDMI/Optical/AUX/USB/Bluetooth modes.
-  Press to select the Bluetooth function. Press and hold to enter the pairing mode.

- 4 **+ / -**
Press to increase or decrease the volume level.
- 5 **LED indicator**
Red: in standby mode.
Purple: in HDMI ARC mode.
Green: in AUX mode.
Blue: in Bluetooth mode.
Yellow: in Optical mode.
Cyan: in USB mode.
- 6 **Sound Mode LED indicator**
Flashing mode of LED indicators for MUSIC / MOVIE / TV.
- 7 **AC input power connector**
- 8 **AUX input connector**
- 9 **Optical input connector**
- 10 **HDMI ARC connector**
- 11 **USB Type A connector**

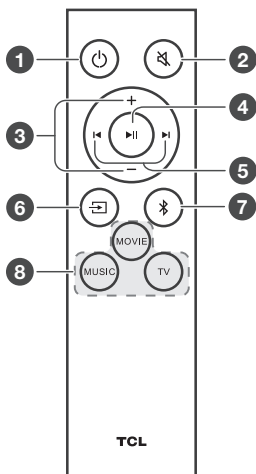
Overview of the remote control



- 1 
Press to turn the Sound Bar on or to standby mode.
Long press to reset the Sound Bar.
- 2 
Press to mute or unmute the sound.
- 3 **+/-**
Press to increase or decrease the volume level.

4 

Play/pause/resume playback in Bluetooth/USB mode. In Bluetooth mode, press and hold for 3 seconds to disconnect the Bluetooth device and enter pairing status.

5 

Press to skip to previous or next track in Bluetooth/USB mode.

6 

Press to switch the audio source among HDMI/Optical/AUX/USB/Bluetooth modes.

7 

Press to switch the audio source to Bluetooth mode.

8 **MOVIE / MUSIC / TV**

Press to select the equalizer (EQ) effect when you are watching **TV** or **movie** or listening to **music**.

Set up your Sound Bar system

Notes

- Make sure you read all the safety information before you mount the Sound Bar on the wall.
- Make sure you use screws provided or specified by the authorized manufacturer.
- TCL Overseas Marketing Limited bears no responsibility for accidents or damage caused by improper wall mounting and screws installation or insufficient wall strength, etc.
- Additional tools (not supplied) are required for installation.

Mount your Sound Bar on the wall

You can choose to place your Sound Bar below the center of your TV or mount it on the wall.

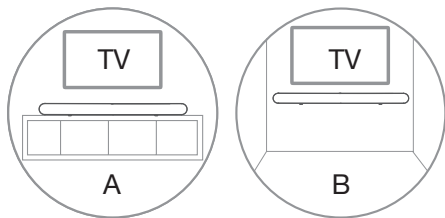

- 1 Place the supplied wall mount template on the wall. Make sure the wall mount template is at least 5cm below the center of the TV.
- 2 Use a level to make sure the wall mount template is positioned accurately.
- 3 Use the tape to stick the wall mount template firmly on the wall.
- 4 Mark on the wall using each marking on the template through the mounting holes.
- 5 Take away the wall mount template.
- 6 Drill a screw hole at each marking on the wall.

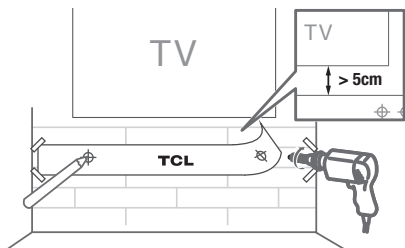

- 7 Screw off the rubber cushions from the sound bar.
(Reserve the rubber cushions for future use)
- 8 Screw on the wall brackets to the sound bar.
- 9 Insert the supplied screws into the wall anchors.
- 10 Fix and tighten the screws on the wall, and please leave 4mm between the screw heads and the wall.

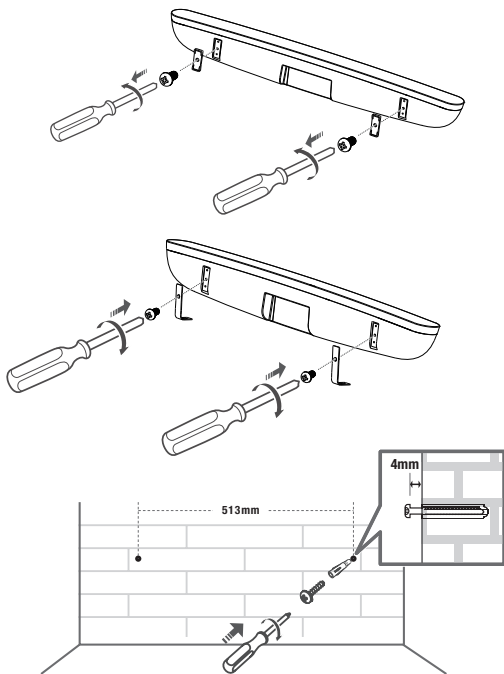

11 Hang the Sound Bar on the screws.

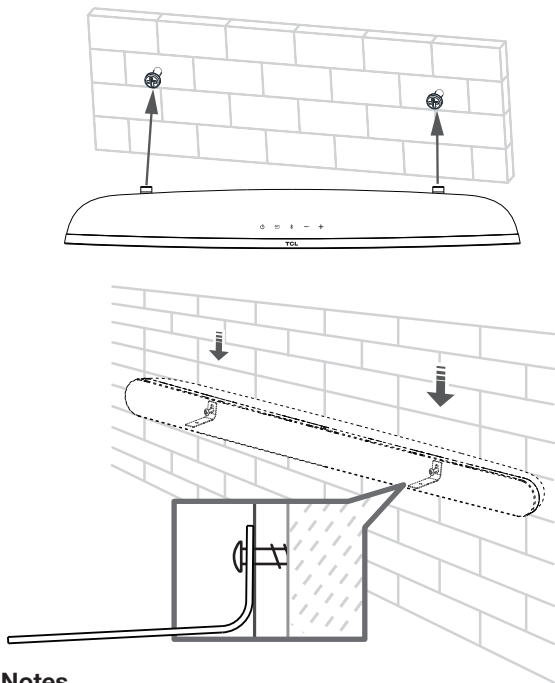

Notes

- Check the installation location before you mount the Sound Bar on the wall (see 'Mount your Sound Bar on the wall' on page 10).
- You may consider to connect the cables first before mounting the Sound Bar on the wall.

Install/replace the remote control batteries

Warnings

- *Danger of explosion if battery is incorrectly replaced. Replace only with the same or equivalent type.*

- 1 Open the battery compartment, remove the old batteries if necessary.
- 2 Place two new AAA batteries into the battery compartment with the correct polarity (+/-).
- 3 Close the battery compartment.

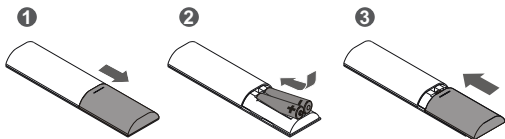

3 Connect your Sound Bar system

After you have fixed the position of the Sound Bar you can start connecting it to your TV or other devices and listen to the audio through your Sound Bar. Make sure you have muted the audio of your TV or device. For information, check the user manual of your TV or device.

Connect with an HDMI cable

Note

- Make sure your TV or device supports the HDMI ARC feature. For information, check the user manual of your TV or device.

Connect one end of an HDMI cable to the HDMI ARC input connector on your Sound Bar and another end to the HDMI ARC output connector of your TV or device.

To get the best possible audio experience using an HDMI cable, follow below given steps:

- 1 Connect your Sound Bar to HDMI input marked **(ARC)** on your TCL TV.
- 2 Press the **Settings** button on your TCL TV remote.
- 3 Navigate to System options.
- 4 Set T-Link on the TV to **On**. (This feature may be called, Anynet+, SimpLink, BRAVIA Link, EasyLink or VIERA Link*.)

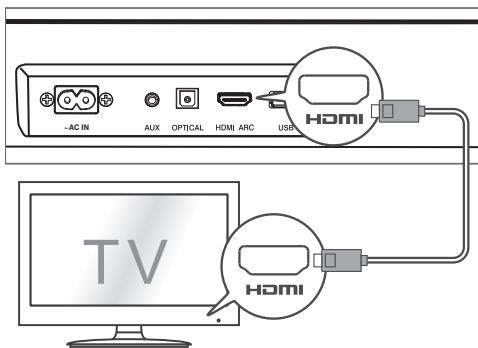

★ All technology names mentioned are the trademarks or registered trademarks of their respective companies.

Connect with an optical cable

- 1 Remove the protective caps from an optical cable when necessary.
- 2 Connect one end of an optical cable to the optical input connector on your Sound Bar and another end to the optical output connector of your TV or device.

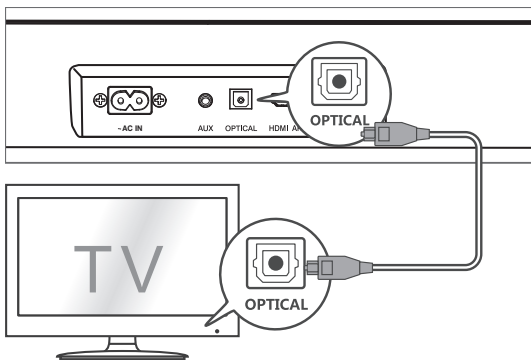

Note

- In case you are not hearing any sound when using HDMI or optical, please go into your TV settings menu and switch audio output to PCM.

Direction for setting up your Sound Bar using an optical cable



Do not bend or kink an optical cable (SPDIF) as it is fragile and can easily get damaged and broken.

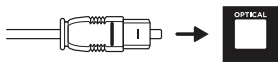

To get the best possible audio experience using the optical cable:

- 1 Press the Home button on your TCL TV Remote.
- 2 Navigate to **Audio** option under **Settings**.
- 3 Uncheck the “**TV speaker enabled**” option.
- 4 Under **S/PDIF** and **ARC**, select **PCM-Stereo**.

Notes

- *Different devices may have different menu options.*
- *Devices such as Blu-ray players, set-top boxes, etc. are also applicable.*

Connect with a 3.5mm-to-3.5mm audio cable

You can either:

- connect one end of a 3.5mm-to-3.5mm audio cable to the AUX input connector on your Sound Bar and another end to the headphone or audio output connector on your TV or device. This will disable the sound of your TV built-in speakers; or
- connect one end of a RCA-to-3.5mm audio cable to the AUX input connector on your Sound Bar and other ends to the TV's audio output connectors.

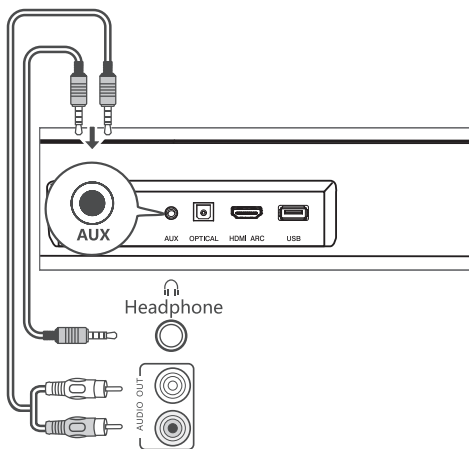

Connect your Sound Bar to power supply

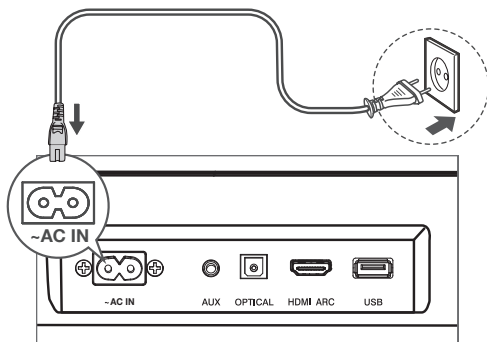

- 1 Make sure that you have completed all other connections before connecting the Sound Bar to power supply.
- 2 Make sure the power supply voltage complies with your country's safety standards (see 'Specifications' on page 30)
- 3 Connect one end of a supplied AC power cord to the AC input connector on your Sound Bar and another end to the power socket on the wall.



Connect the Sound Bar with your Bluetooth device

Notes

- Make sure your wireless device supports the Bluetooth function.
- The operational range between the Sound Bar and your Bluetooth device is approximately 10 meters (without any obstacle between the Bluetooth device and Sound Bar).

- 1 Press  on the top panel of your Sound Bar or remote control to power on the Sound Bar.
- 2 Press and hold  on the top panel of your Sound Bar or remote control.
 - The blue LED flashes quickly. The Sound Bar is ready to pair.
- 3 Power on your Bluetooth device and activate its Bluetooth function.
- 4 Select **TCL 6100** on the pairing list of your Bluetooth device.
 - You hear distinct double beep sound.
 - The blue LED remains on solidly when pairing is successful.

Tip

- If you cannot find the model name **TCL 6100** on your Bluetooth device, press and hold **▶||** on the remote control. You will see the blue LED flashes rapidly. Now the Sound Bar is entering the pairing mode.

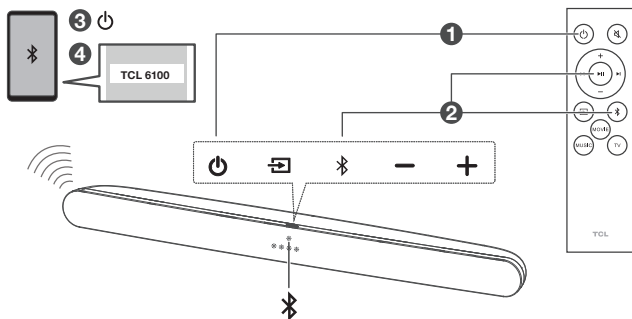

Your Sound Bar system is now set up and ready to use.

- 5 To disconnect the Bluetooth function, you can:
- press **☐** on the Sound Bar or remote control to switch to another source; or
 - disable the Bluetooth function on your device; or
 - press and hold **▶||** on the remote control for 3 seconds.

4 Use your Sound Bar system

Use your Sound Bar with the top panel or remote control

- 1 Make sure the Sound Bar is properly connected to the power supply and sources.
- 2 Press  at the top panel of your Sound Bar or remote control to switch to the correct source.

LED behaviors under different source modes

LED indicators	Source mode
Red	In standby mode
Purple	in HDMI ARC mode
Green	in AUX mode
Blue	in Bluetooth mode
Blue LED flashes slowly	search the paired devices
Blue LED flashes quickly	pairing in progress
Yellow	in Optical mode
Cyan	in USB mode
Yellow LED flashes 3 times	Denotes sound bar is receiving Dolby Audio

* PCM audio format does not show on the display

Note



- After powering on your Sound Bar, if there is no operation performed on either the Sound Bar or remote control within 10 seconds, all LED indicators on the Sound Bar will turn off and light up again when the operation is resumed.



Tip

- You can use more advanced functions on the remote control (see 'Overview of the remote control' on page 8).

Sound settings

You can enjoy your movies or music with your ideal sound.

- Press **+/-** to adjust the volume.
- Press  on the remote control to mute the sound. Press  again to unmute the sound.
- Press the EQ buttons (**MOVIE/MUSIC/TV**) on the remote control to select the equalizer (EQ) effect when you are watching **TV** or **movies** or listening to **music**.

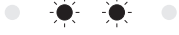
Symbol	Operation	LED indicators
+	Volume up	The four white LEDs light up gradually from left to right
-	Volume down	The four white LEDs fade gradually from right to left
	Volume up to Maximum	The four white LEDs flash twice
	Volume down to Minimum	The left white LED flashes twice
	Mute the Sound	The white LED keeps flashing
	Unmute the Sound	Show the current volume
Select the equalizer (EQ)	MUSIC	
	MOVIE	
	TV	





Listen to music from your Bluetooth device

- 1 Make sure that your device supports A2DP and/or AVRCP. For information, check the specification of your device.
- 2 Pair your Bluetooth device with the Sound Bar (see 'Connect the Sound Bar with your Bluetooth device' on page 22).
- 3 Start listening to music stored in your Bluetooth device through the Sound Bar.
 - If your Bluetooth device supports A2DP, you can listen to music, but you cannot control the playback.
 - If your Bluetooth device supports AVRCP, you can listen to music and control music playback with the remote control. Press ►|| to pause or resume music playback. Press ◀ / ▶ to skip to the previous/next track.

Note

- The operational range between the Sound Bar and your Bluetooth device is approximately 10 meters (without any obstacle between the Bluetooth device and the Sound Bar).

Use the USB cable or device

- 1 Connect the USB device to the USB Type A connector on your Sound Bar.
- 2 Press  on the Sound Bar or remote control, until the cyan LED is on.
- 3 You can now listen to music through the Sound Bar.
 - To pause or resume music, press  on the remote control.
 - To skip to the previous or next track, press  or  on the remote control.

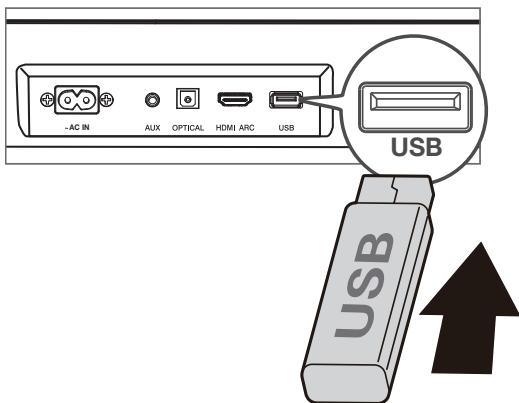

Operation	LED indicators
Listen to music.	The cyan LED is on.
Press ► to pause the music.	The cyan LED keeps flashing

Tip

- This Sound Bar can support USB devices of up to 32GB memory and the supported file format is MP3.

5 Specifications

Sound Bar

- Power adapter: AC~100-240V, 50/60Hz
- Power consumption: 20W
- Power consumption at standby mode: $\leq 0.5W$
- Impedance: 6 Ω
- Frequency response: 150 Hz-20 kHz
- Dimensions (WxHxD): 800x62x107mm
- Weight: 1.8 kg
- Operating temperature: 0°C - 45°C

Bluetooth

- Bluetooth version: 4.2, Bluetooth profile - Bluetooth stereo supported (Advanced Audio Distribution Profile - A2DP; Audio Video Remote Control Profile - AVRCP)
- Frequency range: 2402 Mhz – 2480 Mhz
- Max transmitting power: 13dBm

Remote control

- Distance/Angle: 6m/ 30°
- Battery type: 1.5V AAA battery x 2, user replaceable.

6 Notice

Declaration of conformity

Hereby, TCL Overseas Marketing Limited declares that this product is in compliance with the essential requirements and other relevant provisions of Directive 2014/53/EU. You can find the Declaration of Conformity on www.tcl.com.

Disposal of your old product and battery



Your product is designed and manufactured with high quality materials and components, which can be recycled and reused.



This symbol on a product means that the product is covered by European Directive 2012/19/EU.



This symbol means that the product contains a battery covered by European Directive 2013/56/EU which cannot be disposed of with normal household waste. Inform yourself about the local separate collection system for electrical and electronic products and batteries. Follow local rules and never dispose of the product and batteries with normal household waste. Correct disposal of old products and batteries helps prevent negative consequences for the environment and human health.

Remove the disposable battery

To remove the disposable batteries, see the section 'Replace the remote control battery'.

Environmental protection and sustainability

We have omitted all unnecessary packaging and make sure it is eco-friendly and sustainable.

Trademarks



The Bluetooth® word mark and logos are registered trademarks owned by Bluetooth SIG, Inc. and any use of such marks by TTE Corporation is under license. Other trademarks and trade names are those of their respective owners.



Manufactured under license from Dolby Laboratories. Dolby, Dolby Audio, and the double-D symbol are trademarks of Dolby Laboratories Licensing Corporation.



The Adopted Trademarks HDMI, HDMI High-Definition Multimedia Interface, and the HDMI Logo are trademarks or registered trademarks of HDMI Licensing Administrator, Inc. in the United States and other countries.

7 FAQ

No power

- Make sure the AC power cord and AC input connector are connected properly.
- Make sure there is power supply.
- Make sure the Sound Bar has turned on.

No sound

- Make sure the audio cable is connected to the Sound Bar and your device.
- Make sure you have selected the correct source.
- Press **+** to increase the volume level.
- Make sure the Sound Bar is not muted.

The remote control does not work.

- Make sure you have selected the correct source.
- Make sure the distance of remote control and the Sound Bar is within operational range.
- Make sure the battery is correctly inserted and is working.
- Make sure the remote control is close to the remote control sensor of the Sound Bar.

I hear distorted sound.

- Make sure all cables are properly connected.
- Make sure you have selected the correct source.
- Make sure the TV is muted if you play audio from the TV.

I cannot find the Bluetooth name of this Sound Bar on my Bluetooth device.

- Make sure the Bluetooth function is activated on your Bluetooth device.
- Make sure the Sound Bar has paired with your Bluetooth device.

TCL support:

Please visit www.tcl.com

**WE ARE
READY TO
HELP** contact us first
with any questions



**TAKE CARE WHEN
REMOVING THE SOUND BAR**